

M16301510

04-07

The manufacturer reserves the right to modify the items described in this brochure.
El fabricante se reserva el derecho de modificar los modelos descritos en el presente libro de instrucciones.
Le fabricant se reserve le droit de modifier les modèles décrits dans la brochure.

express PRESSURE COOKER

The Single Most Important
Piece of Cookware
You'll Ever Own

User's Manual

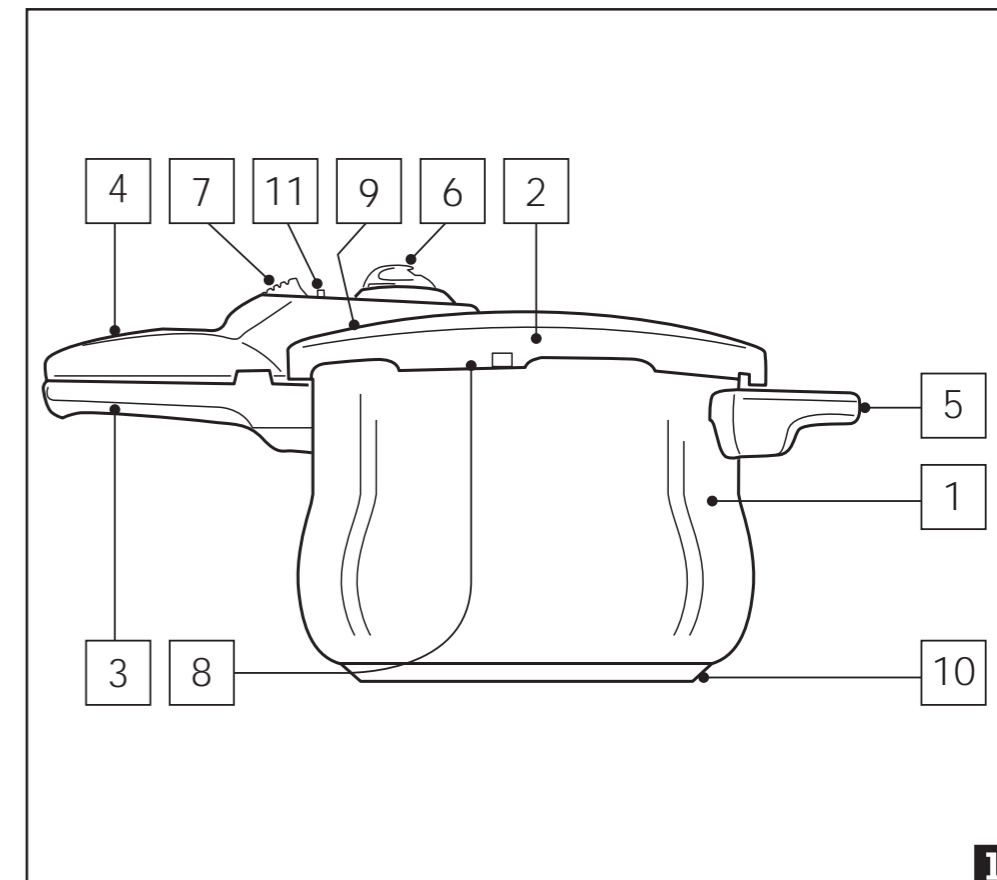

- | | |
|------------------------|---------------------------------|
| 1. Pressure Cooker Pot | 7. Pressure Safety Lock |
| 2. Lid | 8. Rubber Gasket |
| 3. Base Handle | 9. Automatic Safety Valve |
| 4. Lid Handle | 10. Thermo Heat Conductive Base |
| 5. Support Grip | 11. Indicator |
| 6. Operating Valve | |

FAGOR AMERICA, INC.
PO Box 94
Lyndhurst, N.J. 07071
Web page: www.fagoramerica.com
Email: info@fagoramerica.com

Figures 2-9 (as discussed in User's Manual)

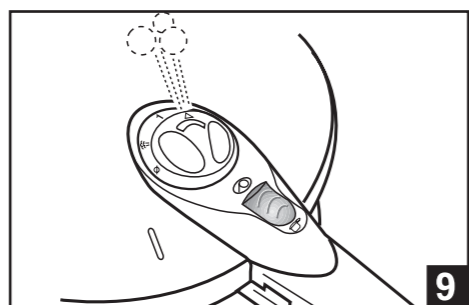
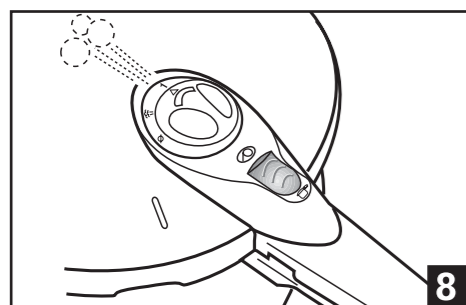
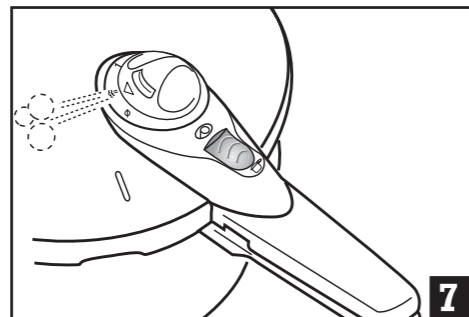
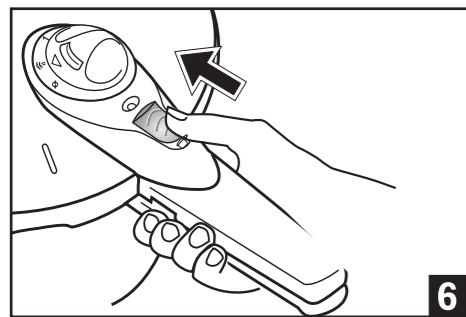
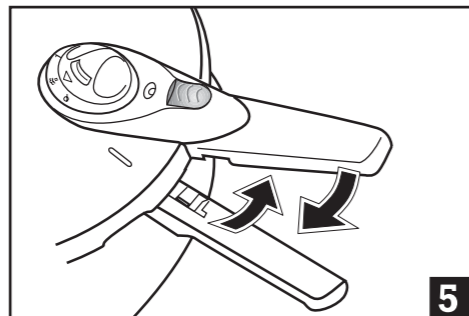
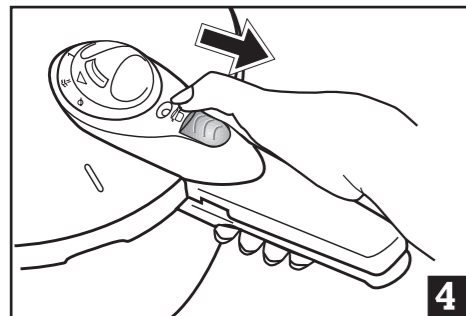
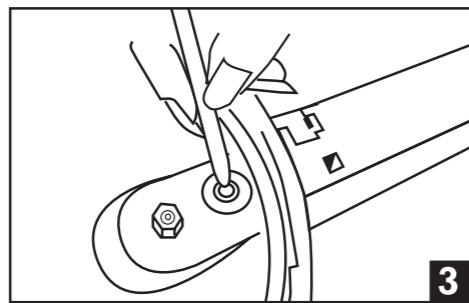
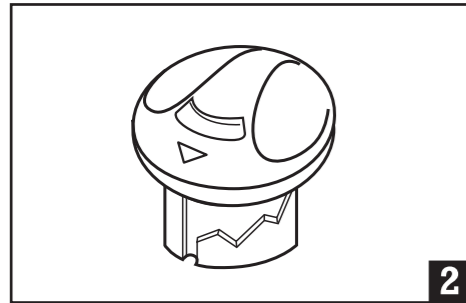

Figures 10-16 (as discussed in User's Manual)

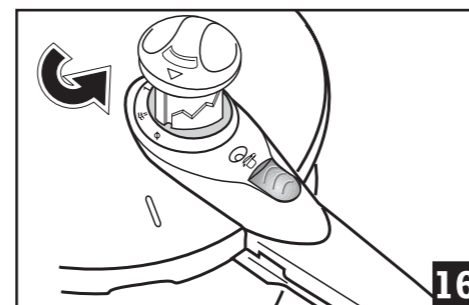
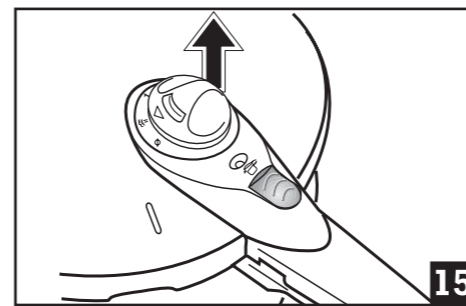
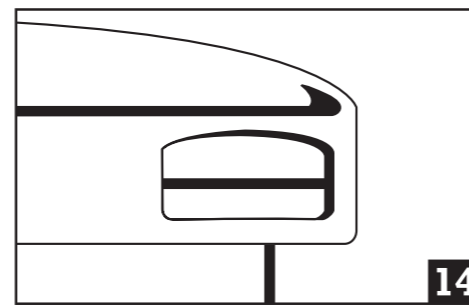
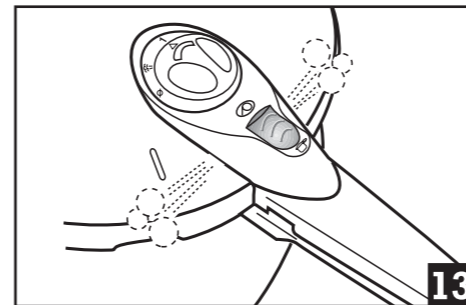
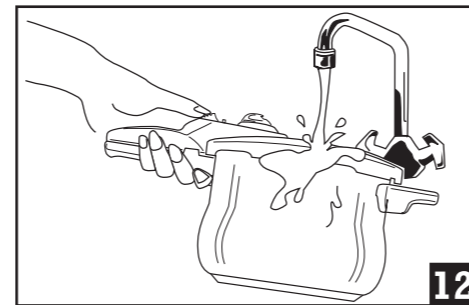
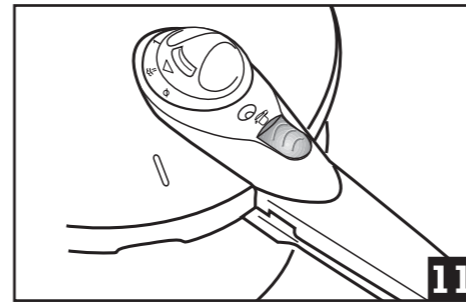
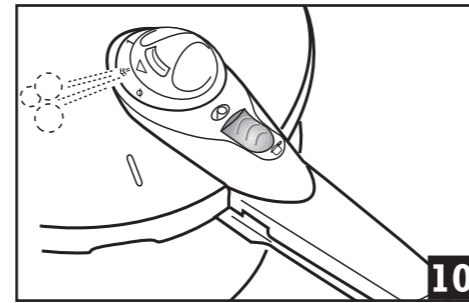

LIMITED WARRANTY

This pressure cooker is guaranteed to be free from defects in material and workmanship for a period of TEN YEARS from the date of purchase by the first user, provided that the unit is used in accordance with the use and care instructions supplied, and for household use only.

Moving and/or perishable parts such as gaskets, internal component parts, etc. which are subject to normal wear and tear are excluded from the warranty.

Also excluded are all defects resulting from accident, damaged suffered in transit, misuse or negligence (including overheating and boiling dry), normal wear and tear such as scratches, dulling of the polish or staining, etc., and repairs or manipulations carried out by unauthorized or non-qualified personnel.

If repairs become necessary during the warranty period, please return the unit, postage pre-paid to:

FAGOR AMERICA, INC.
Sales Service Department
392-400 SEVENTH AVENUE
NEWARK, NJ 07107

After inspection to confirm that the claim satisfies the warranty conditions, the defective piece will, at the discretion of the manufacturer, be repaired or replaced free of charge.

This warranty is in lieu of all other warranties and representations expressed or implied and all other obligations or liabilities on our part.

Incidental or consequential damages are excluded. Some states do not allow exclusions or limitations on incidental or consequential damages or on implied warranties so the above exclusions or limitations may not apply to you.

This warranty gives you specific legal rights and you may have other rights which vary from state to state.

For spare parts or assistance not requiring the return of the product itself, please contact our Customer Service Department at 1-800-207-0806.

FAGOR AMERICA, INC.

WARRANTY REGISTRATION CARD

Mr./Mrs./Ms.: _____

Telephone: _____

Address: _____

Date of Purchase: _____

Name of Dealer: _____

Suggestion: _____

Name of Product: _____

Model No: _____

Size: _____

Important Notice: Please complete and mail this warranty registration card immediately to protect your warranty service.